

safe·n·sound
CONVERTIBLE CAR SEAT

Suitable from birth to 4 years (approx)

Instructions for Installation & Use

Series No. BS0072K-020133

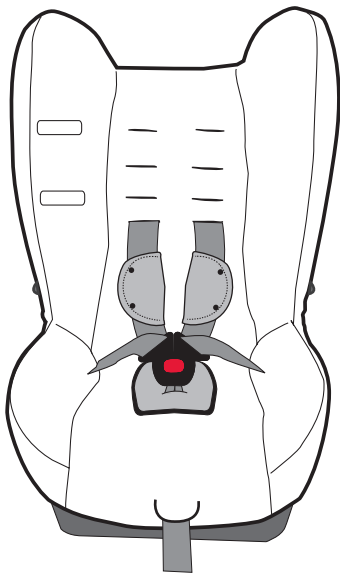

IMPORTANT:

KEEP THIS BOOKLET IN THE PLACE PROVIDED ON THE CHILD RESTRAINT

SEATBELT QUICK SETUP REARWARD FACING

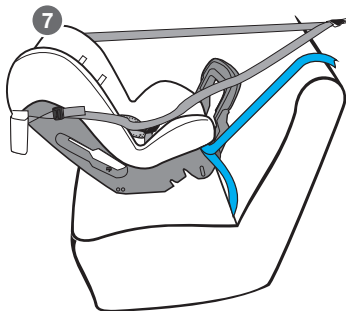
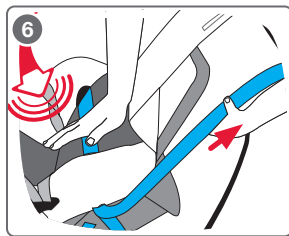
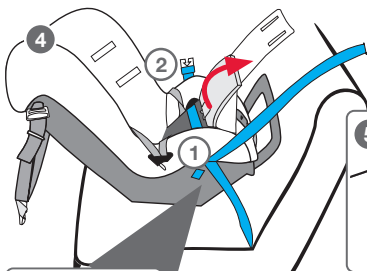
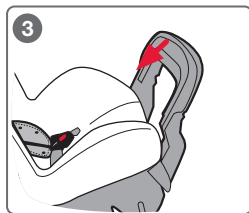
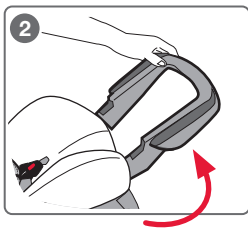
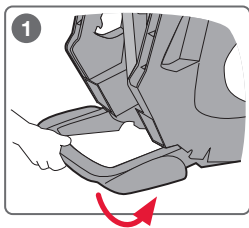

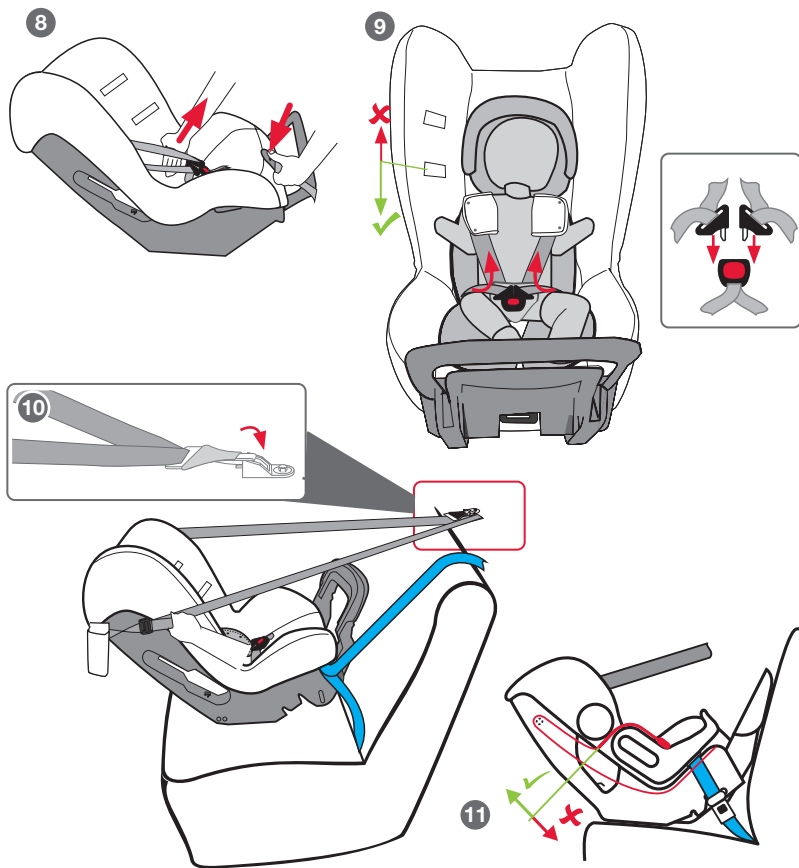

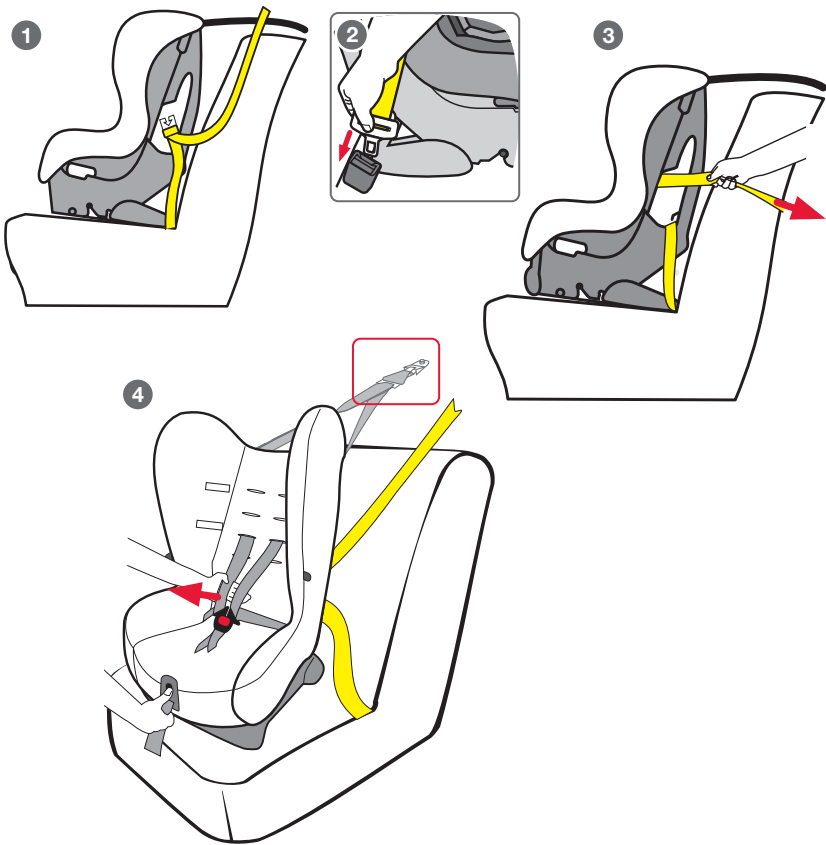

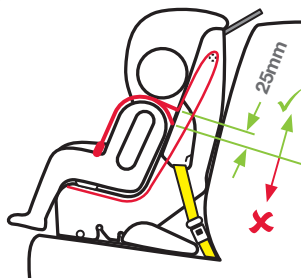
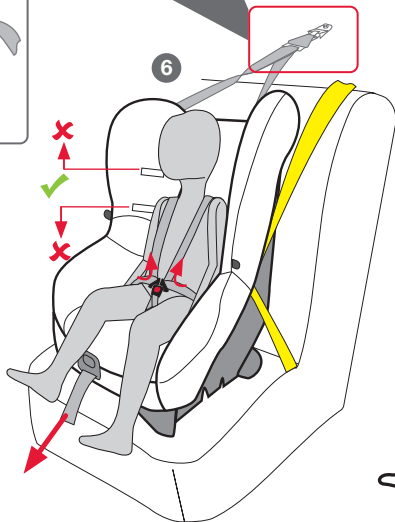
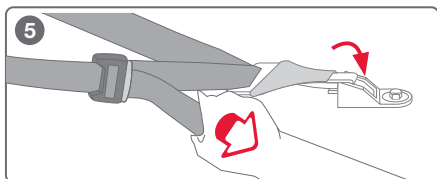

To be used only in a rearward-facing position until the infant's shoulders reach the lower shoulder height marker (approximately 12 months of age). Then to be used in a forward-facing position until the child's shoulders reach the upper shoulder height marker (approximately 4 years of age).

Continue to use this child restraint until the child reaches this limit.

Do not use forward facing until child's shoulders are above the lower shoulder height marker. Infants are at risk of serious injury if they face forward too early.

Children are at risk of serious injury if they move to booster seats too early.

Children who have outgrown this restraint are safest in a larger child restraint with an in-built harness or a booster seat until their shoulders reach the upper shoulder height marker of the restraint.

للاستخدام فقط في الوضعية المواجهة للخلف، حتى يصل كتفا الطفل إما إلى الإشارة السفلية لارتفاع الكتف (حوالي 12 شهرا من العمر) أو إلى الإشارة المتوسطة لارتفاع الكتف (حوالي 3-2 سنوات من العمر). ثم الاستخدام في (الوضعية المواجهة للأمام حتى يصل كتفا الطفل إلى الإشارة العلوية لارتفاع الكتف (حوالي 4 سنوات من العمر استمر في استخدام حاجز الأطفال هذا لحين وصول الطفل إلى هذا الحد لا تستخدم الوضعية المواجهة إلى الأمام إلا عندما يكون كتفي الطفل أعلى من علامة ارتفاع الأكتاف السفلية يكون الرضع في مخاطرة للتعرض إلى الإصابات الخطيرة إذا تم توجيههم إلى الأمام بصورة مبكرة أكثر من اللازم

يكون الأطفال في مخاطرة للتعرض إلى الإصابات الخطيرة إذا ما انتقلوا إلى مقاعد الأمان المرتفعة بصورة مبكرة أكثر من اللازم

يكون الأطفال الذين كُبر حجمهم عن هذا الحاجز أكثر أماناً في حاجز أطفال ذو مقاس أكبر ومزود بأحزمة مدمجة أو مقعد أمان مرتفع حتى تصل أكتافهم إلى علامة ارتفاع الأكتاف العلوية للحاجز

Chỉ được sử dụng ở vị trí hướng mặt về phía sau cho đến khi vai của bé cao tới vạch ghi độ cao của vai ở dưới cùng (khoảng 12 tháng tuổi). Sau đó sẽ được sử dụng ở vị trí hướng mặt về phía trước cho đến khi vai của bé cao tới vạch ghi độ cao của vai ở trên cùng (khoảng 4 tuổi).

Hãy tiếp tục sử dụng ghế an toàn em bé này cho đến khi em cao tới giới hạn này.

Không sử dụng hướng mặt về phía trước cho đến khi vai của bé ở trên vạch ghi độ cao của vai ở dưới cùng.

Bé sơ sinh có nguy cơ bị chấn thương nghiêm trọng nếu hướng mặt về phía trước quá sớm. Trẻ em có nguy cơ bị chấn thương nghiêm trọng khi đổi sang ghế trẻ em (booster) quá sớm.

Các em nào lớn hơn ghế em bé (restraint) này được an toàn nhất là đặt trong ghế em bé lớn hơn với đai nịt gắn sẵn hoặc ghế trẻ em (booster) cho đến khi vai của em cao tới vạch ghi độ cao của vai ở trên cùng.

Magagamit lamang sa isang nakaharap sa likod na posisyon hanggang sa maabot ng balikat ng sanggol ang ibabang marka ng taas ng balikat (humigit-kumulang 12 na buwang edad). Pagkatapos ay magagamit sa isang nakaharap sa unahan na posisyon hanggang sa maabot ng mga balikat ng bata ang itaas na marka ng taas sa balikat (humigit-kumulang 4 na taong gulang).

Ipagpatuloy ang paggamit ng pampigil ng bata na ito hanggang sa maabot ng bata ang limitasyong ito.

Huwag gamitin sa isang nakaharap sa unahan na posisyon hanggang sa malampasan ng mga balikat ng bata ang ibabang marka ng taas ng balikat

Ang mga sanggol ay nasa seryosong peligro ng pagkapinsala kung sila ay haharap ng masyadong maaga.

Ang mga bata ay nasa seryosong peligro ng pagkapinsala kung sila ay masyadong maagang ililipat sa mga upuang booster.

Ang mga batang napagkalakhan na ang pampigil na ito ay pinakaligtas sa isang mas malaking pampigil sa bata na may kasamang guwarnisyon o isang upuang booster hanggang sa maabot ng kanilang mga balikat ang itaas na marka ng taas ng balikat ng pampigil.

أبي رقت) ةيولفسل فاتكألأ اعافترا ةمالع إلل عي ضرلأ يف تك لصي يتح فلخلأ إلل ةهءاوملأ ةيعضولأ يف طقف هءاءءسا
فاتكألأ اعافترا ةمالع إلل لفطلأ لوصو نيءل اءه لافطألأ زءاء مءاءءسا يف تك لصي يتح مامألأ إلل ةهءاوملأ ةيعضولأ يف هءاءءسا مءي مء نمو . (رءش 12 رم ع يف
(ءاونس 4 رم ع يف أبي رقت) ةيولعل

ءءل اءه إلل لفطلأ لوصو نيءل اءه لافطألأ زءاء مءاءءسا يف رمءسا

ةيولفسل فاتكألأ اعافترا ةمالع نم إلل لافطألأ يف تك نوئي مءءن ال مامألأ إلل ةهءاوملأ ةيعضولأ مءءءسا ال

مءاللل نم رءك ةرءبم ةروصب مامألأ إلل مءهءي ءوء مء اءل ةرئيءلأ ءاباصال إلل ضرءل لل ةرطاءم يف ع ضرلأ نوئي

نم رءك ةرءبم ةروصب ةعءءرءم لل نامألأ ءعاقم إلل اولقءءنا ام اءل ةرئيءلأ ءاباصال إلل ضرءل لل ةرطاءم يف لافطألأ نوئي
مءاللل

عءءرءم نامألأ ءعقم وأ ءءءءم ءمءءب ءومءو رءبء سراقم وء لافطألأ زءاء يف أنام رءك زءاءل اءه نع مءمءءء رءب نيءل لافطألأ نوئي
زءاءل لل ةيولعل فاتكألأ اعافترا ةمالع إلل مءفءكأل لصء يتح

Da utilizzare solo in posizione rivolta all'indietro fino a quando le spalle del bambino raggiungono il marcatore di altezza inferiore (circa 12 mesi di età). Dopo di che, può essere usato in un senso di marcia fino a quando le spalle del bambino raggiungono il marcatore di altezza superiore (circa 4 anni di età).

Continuare a utilizzare questo sistema di ritenuta del bambino fino a quando raggiunge questo limite.

Non utilizzare nel senso di marcia fino a quando le spalle del bambino superano il marcatore di altezza inferiore.

I neonati sono a rischio di lesioni gravi se messi in posizione frontale troppo presto.

I bambini sono a rischio di lesioni gravi se si muovono dal seggiolino troppo presto.

I bambini che hanno superato la marcatura sono più sicuri in un sistema di ritenuta per bambini più grande con imbracatura interna o in un seggiolino fino a quando le spalle raggiungono il marcatore di altezza superiore della spalla del sistema di ritenuta.

Na χρησιμοποιείται μόνο σε θέση στραμμένο προς τα πίσω μέχρι οι ώμοι του βρέφους να φτάνουν τον χαμηλότερο δείκτη ύψους ώμου (περίπου 12 μηνών). Στη συνέχεια να χρησιμοποιείται σε θέση στραμμένο προς τα εμπρός μέχρι οι ώμοι του παιδιού να φθάνουν τον ανώτερο δείκτη ύψους ώμου (περίπου 4 ετών).

Συνεχίστε να χρησιμοποιείτε αυτό το σύστημα συγκράτησης βρεφών μέχρι το παιδί να φτάσει σε αυτό το όριο.

Μην το χρησιμοποιείτε στραμμένο προς τα εμπρός μέχρι οι ώμοι του παιδιού να είναι πάνω από τον χαμηλότερο δείκτη ύψους ώμων.

Τα νήπια κινδυνεύουν με σοβαρό τραυματισμό αν κοιτάζουν προς τα εμπρός πολύ νωρίς.

Τα παιδιά διατρέχουν κίνδυνο σοβαρού τραυματισμού, εάν μετακινηθούν σε βοηθητικά καθίσματα πολύ νωρίς.

Τα παιδιά που έχουν ξεπεράσει αυτό το σύστημα συγκράτησης είναι ασφαλέστερα σε μία μεγαλύτερη παιδική διάταξη συγκράτησης με ενσωματωμένο ιμάντα ή βοηθητικό κάθισμα μέχρι οι ώμοι τους να φθάνουν τον ανώτερο δείκτη ύψους ώμου της διάταξης συγκράτησης.

Sólo debe ser utilizado orientado hacia atrás hasta que los hombros del niño alcancen el marcador de altura inferior (aproximadamente a los 12 meses de edad). Posteriormente debe utilizarse orientado hacia adelante hasta que los hombros del niño alcancen el marcador de altura superior (aproximadamente a los 4 años de edad).

Utilice este sistema de seguridad infantil hasta que el niño alcance ese límite.

No utilice la silla orientada hacia adelante hasta que los hombros no sobrepasen el marcador de altura inferior.

El niño corre el riesgo de sufrir lesiones graves si se utiliza la silla orientada hacia adelante antes de tiempo.

El niño corre el riesgo de sufrir lesiones graves si se lo traslada antes de tiempo a un asiento elevador.

El niño que ya no quepa en este sistema de seguridad estará más seguro en un asiento para niños más grande con un arnés incorporado o un asiento elevador hasta que sus hombros alcancen el marcador de altura superior del sistema de seguridad.

只用于后向式安装，直到婴儿肩膀达到靠下的肩高标记（大约12个月的宝宝）。然后用于前向式安装，直到婴儿肩膀达到靠上的肩高标记（大约4岁的儿童）。

在儿童达到该座椅上限以前必须不断使用这一安全座椅。

在儿童肩膀未超过靠下的肩高标记之前不得使用前向式坐姿。

婴儿过早乘坐前向式座椅则可能受到严重的伤害。

儿童过早使用垫高椅则可能受到严重的伤害。

个子比该安全座椅大的儿童最安全的做法是乘坐设有内置安全带的更大汽车座椅或垫高椅，直到他们的肩膀达到该座椅靠上的肩高标记。

僅可後向安裝使用，直至嬰兒肩膀達到低位肩高高度標記（大約12個月大）。然後您才能讓其乘坐前向安裝使用的座椅，直至其肩膀達到靠上的肩高標記（大約4歲大）。

孩子應一直採用後向式坐姿，直至其達到後向式坐姿的上限。

孩子肩膀未超過靠下的肩高標記前，切勿採用前向式坐姿。

孩子若過早乘坐前向式汽車座椅，可能會對其造成嚴重的傷害。

急於讓孩子過早地乘坐墊高椅，可能會對其造成嚴重的傷害。

孩子因長大超出此汽車座椅的上限，最安全的做法便是採用更大且有內建式安全帶的汽車座椅，或是乘坐墊高椅，直至其肩膀達到汽車座椅靠上的肩高標記。

No child restraint can guarantee absolute protection from injury in every crash. However, to ensure that your child gets all the protection designed into the restraint PLEASE READ AND FOLLOW THESE INSTRUCTIONS EXACTLY and use only Britax Safe-n-Sound® recommended parts and accessories.

The child should not sit in this restraint in the forward facing mode until their neck muscles are able to support their head however Britax recommends that you keep your child in a rearward facing restraint for as long as possible or until the lower shoulder height marker is reached (approximately 12 months).

Carefully read all the instructions for installation in this book. If in doubt about the method of installation, consult Safe-n-Sound® or agent or a child restraint fitter, or in New Zealand consult the agent for the vehicle.

Regional Road Rules may prohibit the use of a restraint in the front seat of the car until the child is 4 years of age. Check your Regional Road Rules for exemptions.

Always store the instruction book in the pocket provided and tuck pocket under trim cover.

- 10 WARNINGS
- 14 SHOULDER HEIGHT MARKERS & A GROWING CHILD
- 15 SHOULDER HEIGHT MARKERS
- 16 SHOULDER HEIGHT MARKERS & THE NEXT STEP

REARWARD FACING

- 17 FEATURES
- 19 SUITABLE FOR USE
- 20 HOW TO INSTALL
- 28 HOW TO SET-UP
- 31 HOW TO USE
- 35 HOW TO REMOVE

FORWARD FACING

- 37 FEATURES
- 39 SUITABLE FOR USE
- 40 HOW TO SET-UP
- 45 HOW TO USE
- 49 HOW TO REMOVE

AIRCRAFT USE

- 50 SHOULDER HEIGHT MARKERS & THE NEXT STEP

REARWARD FACING

- 54 FEATURES
- 59 ACCESSORIES & FEATURES
- 62 INSTALLATION OF CAR ANCHOR FITTING
- 66 TRAVELLING TIPS
- 67 IN CASE OF CRASH
- 68 WARRANTY

**WARNINGS**

- Fit the restraint firmly to the car seat.
- Fit the harness firmly to the child.
- A loose restraint or harness is dangerous.
- Supervision of children is needed because they may be able to undo the buckles and adjusters.
- Use the restraint exactly as shown in the instructions.
- **DO NOT LEAVE CHILDREN UNATTENDED IN THE CAR.**
- Do not alter or modify this restraint.
- Repairs must only be done by the manufacturer or agent.
- Do not allow the restraint to come into contact with polishes, oils, bleach and other chemicals.
- Destroy the restraint if it has been in a severe crash, even if no damage is visible. See page 67.
- **DO NOT USE THIS RESTRAINT WITHOUT THE COVER.**
- Always secure the loose end of the top tether strap. Do not use the child restraint where this strap may fall into a split in the seat back or off the side of the seat.
- To ensure infant's back is evenly supported, do not put more than one nappy on the baby and make sure the nappy is not thickly folded at the back.
- **DO NOT USE A REAR-FACING CHILD RESTRAINT WHERE AN AIRBAG IS FITTED IN FRONT OF THE SEATING POSITION.**
- Do not harness an infant wrapped in a blanket or swaddled. Any blanket or wrap must only be placed over the harness and infant.
- **ALWAYS ATTACH HOOK AND REMOVE SLACK.**

**IMPORTANT:**

- TO BE USED WITH LAP-SASH OR LAP ONLY SEATBELT IN THE BACK OF MOST CARS WITH FORWARD FACING SEATS.
- This child restraint is not approved for use with any connectors that connect to the car's ISOFIX low anchorages.
- Regularly check the restraint components, straps and other fitments for correct function and condition. If faulty, cease using and seek repair by Safe-n-Sound®.
- IF AN AIRBAG IS FITTED IN THE SEATING POSITION WHERE THE CHILD RESTRAINT IS TO BE FITTED, FOLLOW THE VEHICLE MANUFACTURERS WARNINGS AND INSTRUCTIONS.
- Protect all webbing from abrasion and cutting by sharp corners and edges.
- The restraint should not be purchased or sold as a second hand item. It is recommended not to use child restraints older than 10 years as the protection in an accident may be reduced.
- THIS RESTRAINT IS NOT SUITABLE FOR USE WHERE THE TOP TETHER STRAP MAY FALL INTO A SPLIT IN THE SEAT BACK OR OFF THE SIDE OF THE SEAT.
- Seatbelt extenders are not recommended to be used if the seatbelt is not long enough to secure the child restraint. If seatbelts are too short then seek advice from a child restraint fitter and consider their recommendations before using a seatbelt extender. If you use a seatbelt extender then ensure that the seatbelt buckle does not enter the rearward or forward facing belt paths.
- THIS RESTRAINT MUST BE ATTACHED TO A CHILD RESTRAINT UPPER ANCHORAGE POINT IN THE CAR. REFER TO CAR OWNER'S HANDBOOK FOR LOCATION OF UPPER ANCHORAGE POINTS. REFER TO A CHILD RESTRAINT FITTING STATION IF NO UPPER ANCHORAGE POINTS ARE IN THE MOTOR CAR. Refer to pages 62-65.

NEWBORN

(REARWARD FACING)

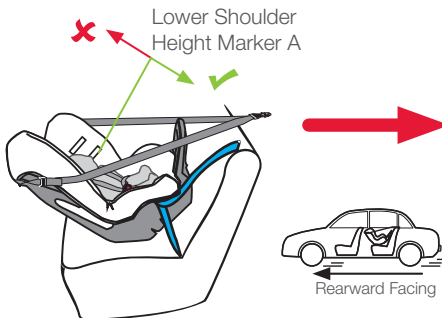
**OLDER BABY**

(REARWARD FACING)

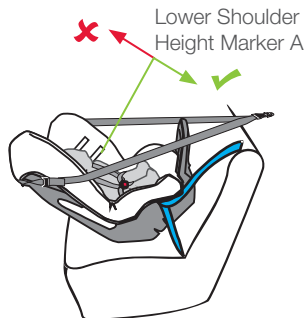
**TODDLER USE**

(FORWARD FACING)

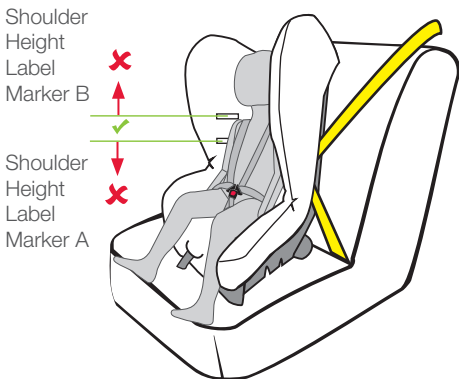

Turn to forward-facing when the child's shoulders reach the lower shoulder height marker.

Move to the next form of child restraint when the child's shoulders reach the Upper Shoulder Height Marker.



 **IMPORTANT: Follow this advice.**

Shoulder height markers are provided on this restraint for a visual indication that the child is safe to ride in this restraint.

MARKER A: LOWER SHOULDER HEIGHT MARKER

When the child's shoulders reach the lower marker, the child restraint must be turned to face towards the front of the vehicle or move the child to another forward facing seat with in built harness. Approximately 12 months of age.

**MARKER B: UPPER SHOULDER HEIGHT MARKER**

When the child's shoulders reach this upper marker, the child is now too big for the child restraint. It is now time to move to the next child restraint. Approximately 4 years of age.

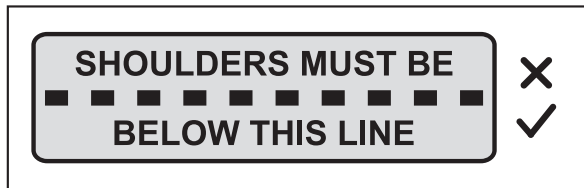

Next type of restraint that can be used in the car for your child.

When your child has outgrown this seat, you can use:

- Use a booster seat suitable for children up to 8-10 years of age with the car's seatbelt.*

OR

- A child may use the vehicle seat and seatbelt without a booster seat if the child's legs hang over the seat edge.

Otherwise if the child's legs do not hang over the edge of the vehicle seat then they need to use a booster seat so that the seatbelt fits correctly and so the child does not slump. A lap seatbelt on the child's abdomen is dangerous.

NOTE: This child restraint includes a booster seat configuration for children 4 years to approximately 6 to 8 years.

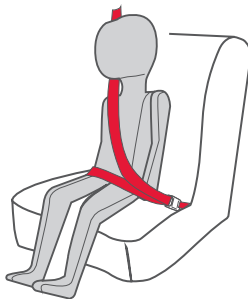
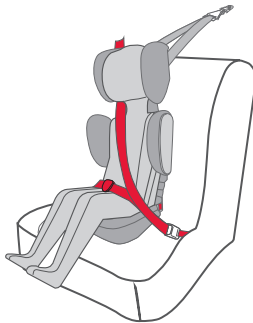

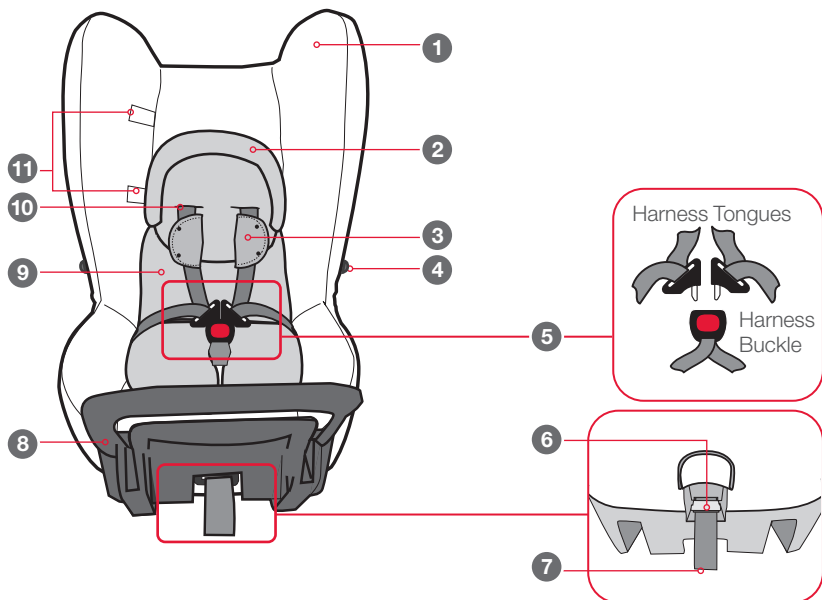

1. Padded cover for baby's comfort
(May vary in style)
2. Head Roll (if supplied)
3. Shoulder Pads (if supplied)
4. Buckle Tongue holders (if supplied)
5. Harness Tongues and Buckle
(Red button)

6. Harness Adjuster
7. Harness Adjustment Strap
8. Stabilising Bar for Rearward Facing
9. Padded Insert (if supplied)
10. Slots for Harness
11. Shoulder Height Markers

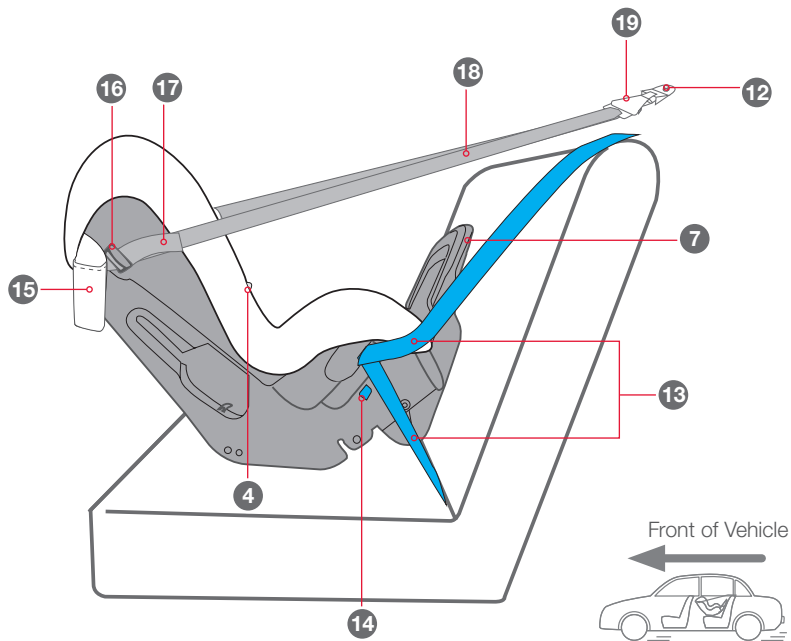

- 12. Vehicle Anchor Fitting
- 13. Vehicle lap-sash seatbelt
- 14. Blue **REARWARD FACING BELT PATH** label
- 15. Top Tether Storage Pocket
- 16. Top Tether Adjuster
- 17. Top Tether Strap Adjuster
- 18. Adjustable Top Tether Strap
- 19. Attachment Clip

Continue to use this child restraint in this rear facing mode until the child's shoulders reach the limit of the lower or middle shoulder height marker before turning the seat to face forward. A younger child's neck muscles may be unable to support their head thus the child should remain rear facing until the neck muscles become stronger.

To ensure that the space is sufficient the purchaser should check the measurement between the seat back of the rear seat and all front seats in the car in which the child restraint is intended to be used. The length may be longer when the headrest is raised in rear facing mode.

Regional Road Rules may prohibit the use of a restraint in the front seat until the child is 4 years of age. Check your Regional Road Rules for exemptions.

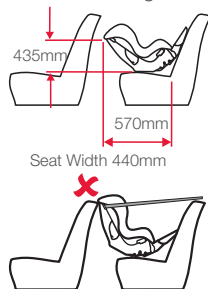

Do not allow the front seat to alter the installed angle of the restraint. It is permissible to allow the restraint to touch the front vehicle seat.



WARNINGS

DO NOT USE RESTRAINT IN REARWARD FACING MODE WITHOUT STABILISING BAR FULLY EXTENDED.

Do not use the restraint without the top tether strap correctly attached to the vehicle anchorage.

DO NOT USE A REAR FACING CHILD RESTRAINT WHERE AN AIRBAG IS FITTED IN FRONT OF THE SEATING POSITION.

If an airbag is fitted in the desired seating position where the child restraint is fitted, follow the vehicle manufacturer's warnings and instructions. Do not use on any vehicle seat which faces sideways or rearwards. Never leave babies or toddlers in a stationary car in the sun because of the risk of heat exhaustion. Ensure babies and toddlers have adequate ventilation and are shaded from direct sunlight through side or rear windows.

CHILD RESTRAINT UPPER ANCHORAGE FITTING

To use this child restraint, the car will need a child restraint upper anchorage fitting in the seating position that you intend to use. Refer to the car owner's handbook.

The upper anchorage fitting is required for attaching the top tether in both rear facing mode and forward facing mode covered later in these instructions.

If no upper anchorage fitting is provided then you will need to install an upper anchorage fitting. Refer to pages 62 to 65.

PREPARING FOR INSTALLING INTO VEHICLE - REARWARD FACING

The restraint is normally packaged in the fully upright forward facing mode. If you need to use it rearward facing you must first fully convert the restraint to rearward facing mode as shown below.

If upper anchorage strap is folded up for storage undo storage strap then lengthen. Fully press adjuster button (A) while pulling upper anchorage strap (B) to lengthen.

Fully press Adjuster Button (A) while pulling Upper Anchorage Strap (B) to lengthen.

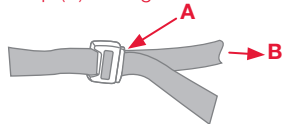

CONVERT TO REARWARD FACING MODE

- Pull the stabilising bar downward to unlock it from the seat.
- Rotate the stabilising bar around so that it is in position at the front of the seat.
- While in position, push down on the stabilising bar to lock into position as shown.

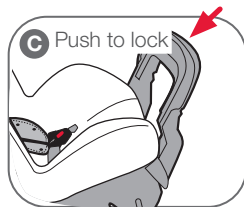
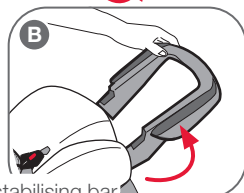

IMPORTANT:

DO NOT USE RESTRAINT IN REARWARD FACING MODE WITHOUT THE STABILISING BAR LOCKED IN POSITION. FOLLOW SPECIFIC INSTRUCTIONS FOR AIRCRAFT USE.

INSTALLING INTO A VEHICLE WITH SEATBELT. (REARWARD FACING)

- A. Position restraint rearward facing in the chosen seating position in the car where a child restraint anchor fitting is installed.

The stabilising bar need not be in contact with the vehicle seatback but must be be extended in position and latched.

Some vehicle seat fabrics (particularly velours) may be damaged by a child restraint used continuously. We recommend the use of a seat protector or thick towel to keep the vehicle seat in good condition.

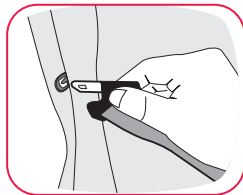

- B. Undo the buckle and place buckle tongues in the Harness tongue holders (if supplied) on each side of the cover.
- C. Remove baby insert (if fitted). Lift the centre panel flap and comfort pad from the inner seat.

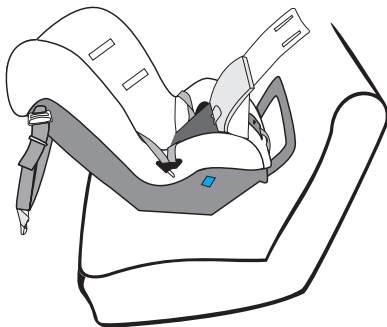

- D. Fully lengthen seatbelt and feed between the comfort pad and the inner seat through seatbelt slot on each side. The slots are labeled in blue - **REARWARD FACING BELT PATH**.
- E. Engage seatbelt buckle and tongue. Push down on the seat (by hand), whilst pulling the sash belt firmly to tighten the seatbelt. This will make the lap belt very tight across the restraint. Whilst holding the seatbelt tension, ensure to remove all slack from lap part of seatbelt by pulling sash belt. For retractor seatbelts, allow excess belt to feed back into retractor.

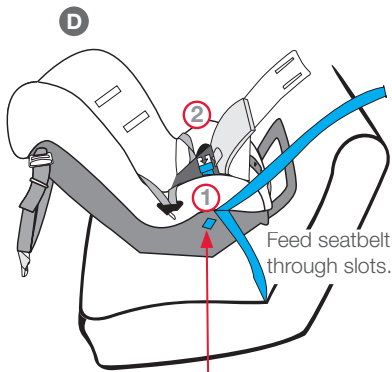

Blue **REARWARD FACING BELT PATH** label

NOTE: Seatbelt buckle and tongue must not rest between restraint cover and restraint. If seatbelt buckle is adjustable, adjust buckle as low as possible away from the restraint.

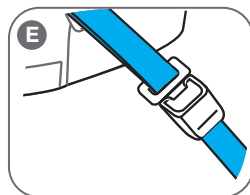

Push down on seat

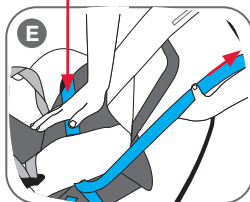

- F. Replace the comfort pad and centre panel flap, ensure the harness buckle is repositioned through the panel, clip any plastic fasteners that retain the cover. For smaller babies replace the insert pad (if supplied). Do not use insert pad if the child's shoulders reach the lower shoulder height marker or the child no longer fits the insert. See page 28 for advice on positioning the shoulder straps.

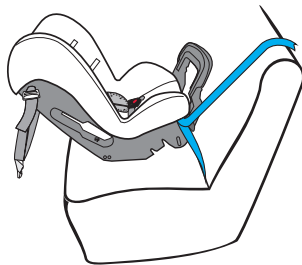

NOTE: Seatbelt extenders should not be used if the seatbelt is not long enough to secure the child restraint. If they are used then the buckle must not enter the seating zone.

- G. Fit the attachment clip to the car's anchor fitting as shown right. Make sure to remove as many twists as possible from the upper anchorage strap.

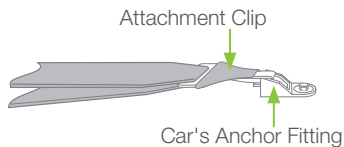

- H. Tighten top tether strap by pulling adjustment strap to remove slack, leave the strap slack on the side the baby will be placed into the seat from. Any slack will be removed once the baby has been harnessed into the seat.
- I. Remove the slack from the adjustable top tether strap by pulling adjustment strap (3). After the baby is fitted in to the harness, remove all slack in the top tether strap and roll up excess strap and place in the pocket provided. Do not tighten the top tether strap such that the restraint is lifted up. Remove slack only.

Fully press Adjuster Button (1) while pulling Upper Anchorage Strap (2) to lengthen.

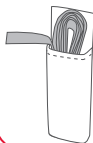
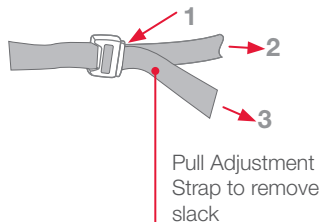

Roll up excess strap and store in the pocket attached to the cover.



CAUTION:

CHILDREN CAN BE INJURED OR RESTRAINTS AND TOP TETHER STRAP DAMAGED BY UNSECURED CARGO IN A COLLISION. SECURE OR REMOVE HAZARDOUS CARGO BEFORE USING THIS CHILD RESTRAINT.

FITTING SUMMARY

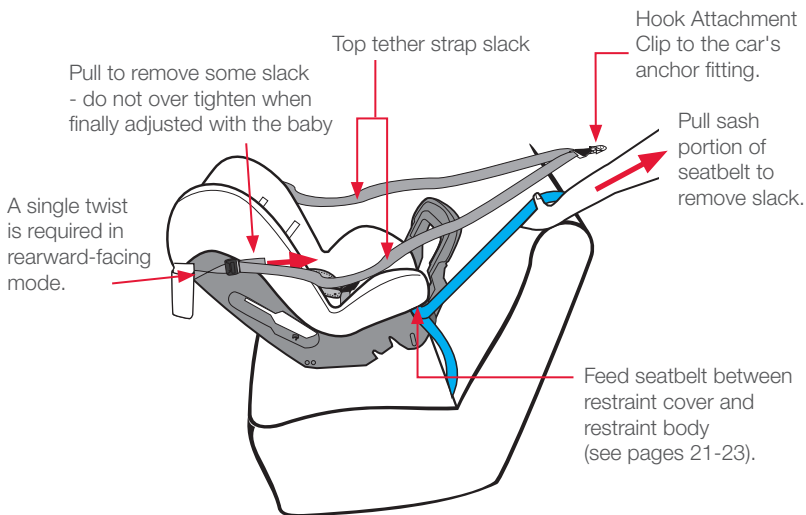
**WARNINGS**

DO NOT USE RESTRAINT IN REARWARD FACING MODE WITHOUT STABILISING BAR FULLY EXTENDED. THE TOP TETHER STRAP MUST ALWAYS BE FITTED WHEN THE CHILD RESTRAINT IS USED IN A VEHICLE. ALWAYS ATTACH THE HOOK AND REMOVE THE SLACK.

IMPORTANT: If using an Extension Strap, positioning the attachment clip above the child may lead to injury in an accident therefore make sure that the attachment clip is not positioned in front of the vehicle seat. Use a shorter extension strap or no extension strap.

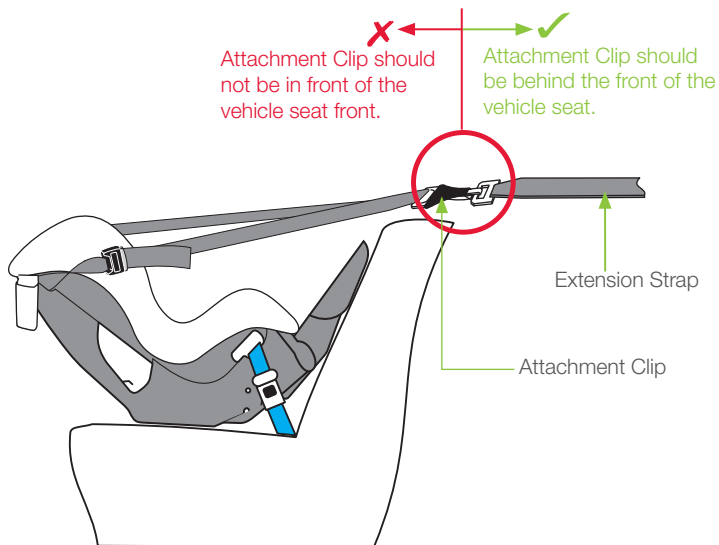

ANGULAR ADJUSTMENT OF RESTRAINT

Some vehicle seats have more rearward slope than others. If the angle of the seat causes the baby to be too upright for comfort, the angle may be altered by placing a firm packing between the seat and the underside of the base. Packing can be a firmly rolled up towel.

If the car's seat is too flat, some packing may be required at the front edge of the base to achieve the recline angle.

**Do not remove all of the installation angle by over packing.
Always leave an angle of approximately 10° - 15°.**

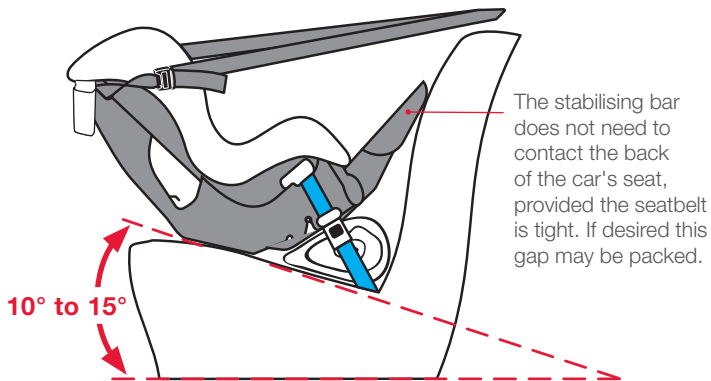

SETTING UP THE HARNESS

- A. Sit the restraint on flat ground and supported from behind so that it will not tip over.
- B. Sit the child comfortably in position.
- C. Determine the desired shoulder strap position and select a slot inline or just above the baby's shoulders.
- D. Remove the child and move the shoulder straps to the desired position using the methods on the next two pages.
- E. Repeat steps A-C to confirm the correct set-up of the built-in harness.

1. Upper shoulder strap slots.
(Forward facing).
2. Middle Upper shoulder strap slots
(Forward facing).
3. Middle Lower shoulder strap slots.
4. Lower shoulder strap slots.
5. Shoulder harness strap.
6. Harness tongues and buckle.
7. Crotch Strap Slot
8. Head Roll (if supplied)

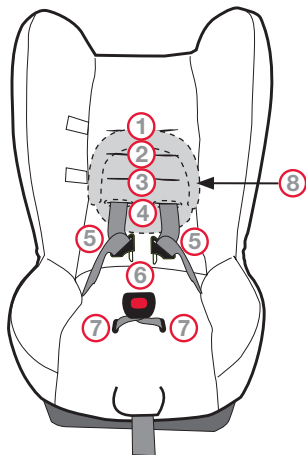

ADJUSTING SHOULDER HARNESS STRAPS HEIGHT

Correct fitment of the harness is very important as it restrains the child in the restraint. The headrest must be in the correct position and the harness must fit firmly around upper torso of the child and be positioned so as to leave the child's arms and legs free.

For children in rear facing mode shoulder straps must be in slots nearest to the child's shoulders, but not lower than the child's shoulders. Always adjust the harness slot position as the child grows. If your child has reached the upper shoulder height marker then the restraint must be converted to Forward Facing mode (refer to Forward Facing section starting on page 37).

REARWARD FACING

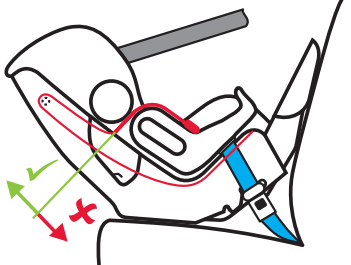

The shoulder straps must be in the slots which are nearest to the child's shoulders, but not lower than the child's shoulders.

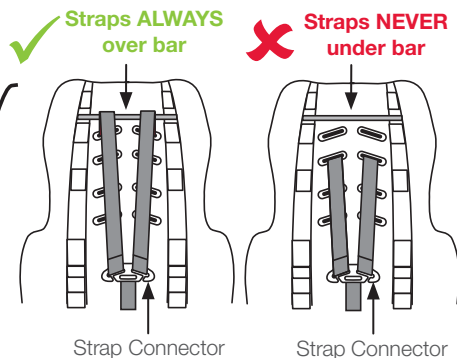

Shoulder straps **must** be threaded through appropriate shoulder strap slots then **over the top** of bar at rear of restraint.



IMPORTANT :

Always adjust the height of the shoulder straps as child grows.

STEPS IN CHANGING SHOULDER STRAP SLOTS

- Remove the restraint from vehicle, if not already removed.
- It is better to change one strap at a time, so that the other strap will be a guide for reassembly.
- At the rear of the restraint, remove one of the harness shoulder straps from Metal Strap Connector by slipping strap through open slot.
- Pull the shoulder strap through slot.
- Insert shoulder strap through restraint slot which will position the shoulder strap level with or above the child's shoulder, **then over the metal cross bar**. Ensure that the shoulder strap passes through matching slots in cover and restraint body. If using an accessory with slots, ensure the straps are threaded through these before inserting the strap in the slots in the backrest.
- Reconnect the strap to the metal strap connector.
- Repeat for the other side.

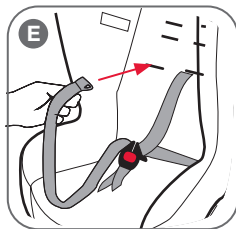
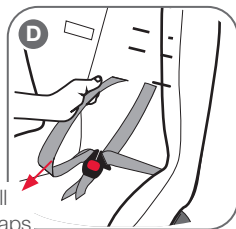
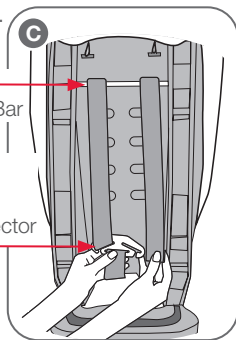

IMPORTANT:

Ensure the shoulder strap is threaded through the slot, then over the top of the bar at the rear of restraint and connected to the metal strap connector.

Do not use the restraint with harness shoulder straps set at different heights or fed through mismatching slots. Ensure harness straps are not twisted and that all straps are secure by pulling each harness strap.

Remove the accessories while adjusting harness. The accessories are not to be used once child reaches the Lower Shoulder Height Marker or if it creates discomfort.

PLACING CHILD INTO RESTRAINT (REARWARD FACING)

When positioning baby into the restraint make sure baby's back is fully supported onto the flat section and the baby's nappy area (bottom) is resting in the bottom curvature as shown. It is recommended that bulky nappies are not used when baby is travelling in the restraint as they can cause incorrect positioning of the baby's back in the restraint.

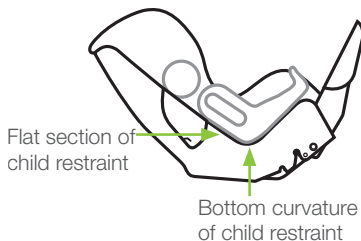

A. Check that the harness shoulder straps are in the correct position. Refer to pages 28 for correct shoulder harness strap height and for setting up the harness.

B. Slacken the top tether strap if not already slack and allow the straps to fall to the sides of the restraint for easy access to the child.

C. Loosen shoulder straps by operating the harness adjuster button or lever and pull both shoulder straps evenly. Pull out the desired amount of slack.

D. If supplied, store the buckle tongues on the buckle tongue holders.

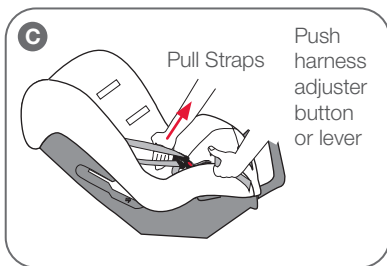

Buckle tongue holder on both sides of the seat. Push tongue inwards to engage.

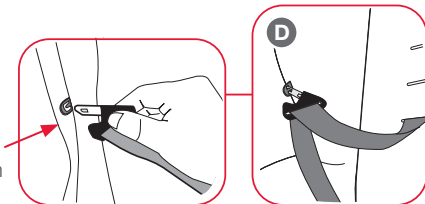

- E. Place baby into child restraint lying on its back so that the buckle is between the baby's legs. Ensure that baby's arms and legs are free. Make sure baby is dressed to allow the Harness Buckle to be pulled up between baby's legs e.g. a jump suit.

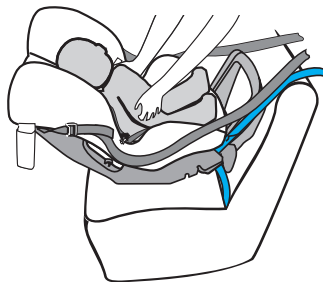

! **CAUTION:**

Do not harness an infant wrapped in a blanket or swaddled as this increases the risk of ejection and injury or death in a crash. The harness needs to fit firmly to the baby, any blanket or other covering may be placed over the harness after the harness is adjusted. Arms and legs must be free and not bound or wrapped together. The legs must sit on each side of the crotch strap.

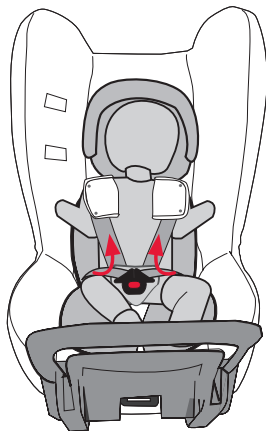

- F. Fit either harness tongue into the harness buckle followed by the other tongue. A click is heard when the last tongue is fully engaged. Should the second tongue not engage - press the red button and reinsert the tongues. Ensure secure engagement by pulling harness straps. If the harness buckle does not engage correctly then it may require cleaning or seek replacement - refer to page 55. **The buckle tongues are fully engaged when both tongues are inserted and a 'click' is heard.**



- G. Ensure slack is removed from harness lap strap by pulling shoulder straps then pull harness adjustment strap to archive a comfortable but firm fit. Ensure that any slack in harness straps is removed. Shoulder harness straps must fit firmly to the child. A loose harness could result in serious injury in an accident. Do not over tighten.

Do not use the restraint if straps do not tighten, contact your local authorised service agent for repair.

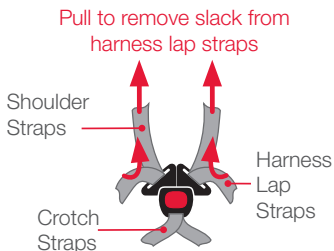

- H. Remove the slack from the top tether strap by pulling adjustment strap as shown.

Ensure the strap is not so tight as to lift the seat or deform the headrest.

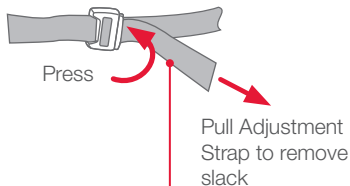

- I. Always roll up excess strap and place in the pocket provided attached to the cover.

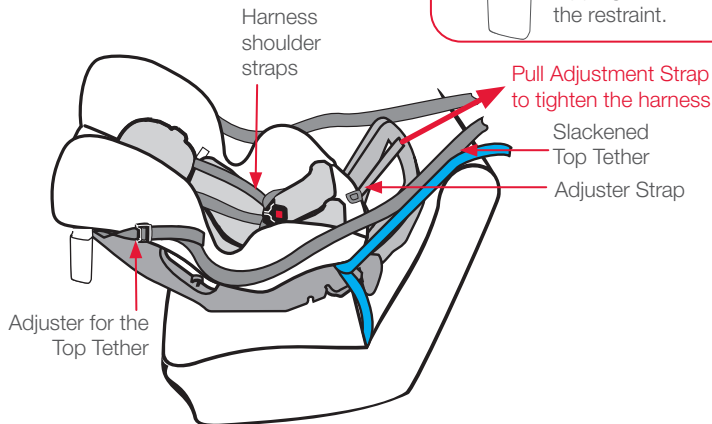
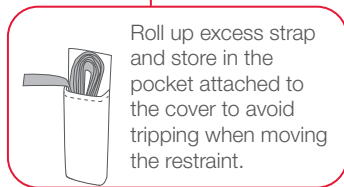

WARNING:

DO NOT LEAVE CHILDREN UNATTENDED IN THE CAR.

CAUTION: A LOOSE HARNESS IS DANGEROUS.

Make sure that nothing is obstructing harness straps and that child's arms and legs are free with the straps in the correct location - see previous page. Do not use the restraint if straps do not tighten, contact Safe-n-Sound® Customer Service on 1300 131 477. THIS RESTRAINT IS NOT SUITABLE FOR USE WHERE THE TOP TETHER STRAP MAY FALL INTO A SPLIT IN THE SEAT BACK OR OFF THE SIDE OF THE SEAT.

IMPORTANT:

The padded insert is designed to provide extra support and comfort and may be used for smaller children. Discontinue use when Baby Padded insert is a tight fit, creates discomfort for larger children, or the child's shoulder reach the lower shoulder height marker. Always secure the loose end of the top tether strap to prevent it hanging out of the car or being accessible by the child. Store in the top tether pocket provided. Store instruction manual in pocket provided and tuck pocket under trim cover.

REMOVING CHILD FROM RESTRAINT

- Press top tether strap adjuster button while pulling top tether straps to slacken. Allow top tether straps to fall to the sides for easy access to child.
- Push and hold the harness adjustment button while pulling both shoulder harness straps to fully slacken the harness.
- Press the red button on harness buckle, both harness tongues will be released. Insert buckle tongues into harness tongue holders to hold harness straps away from the child. Move each shoulder strap to baby's side then pick up baby.

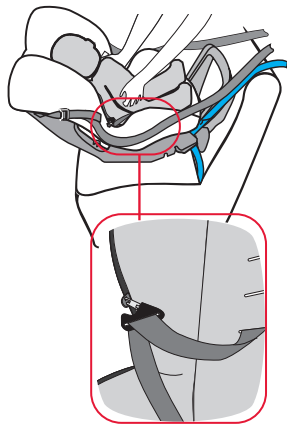

REMOVE RESTRAINT FROM VEHICLE DISCONNECT TOP TETHER AND SEATBELT

- A. Disengage the seatbelt buckle. Remove seatbelt from the restraint belt paths.
- B. Remove the top tether strap from pocket and fully press top tether adjuster button (A) while pulling top tether strap (B) to slacken as shown. In some vehicles loosening of the top tether strap may be difficult. If so, try pushing the restraint against the vehicle seat back or slightly lifting the restraint to release the tension.
- C. Disengage the attachment clip from upper anchorage fitting. The child restraint is now disconnected.
- D. Roll up and store the loose top tether strap in the pocket provided to avoid tripping
- E. To convert the restraint from Rearward Facing mode to Forward Facing mode, follow instructions on page 55.
- F. Disengage seatbelt tongue from buckle and remove the seatbelt from the restraint belt paths. Allow seatbelt to feed back into seatbelt retractor.

Fully press Adjuster Button (A) while pulling Top tether Strap (B) to lengthen.

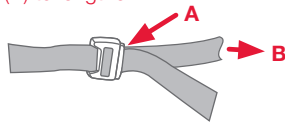

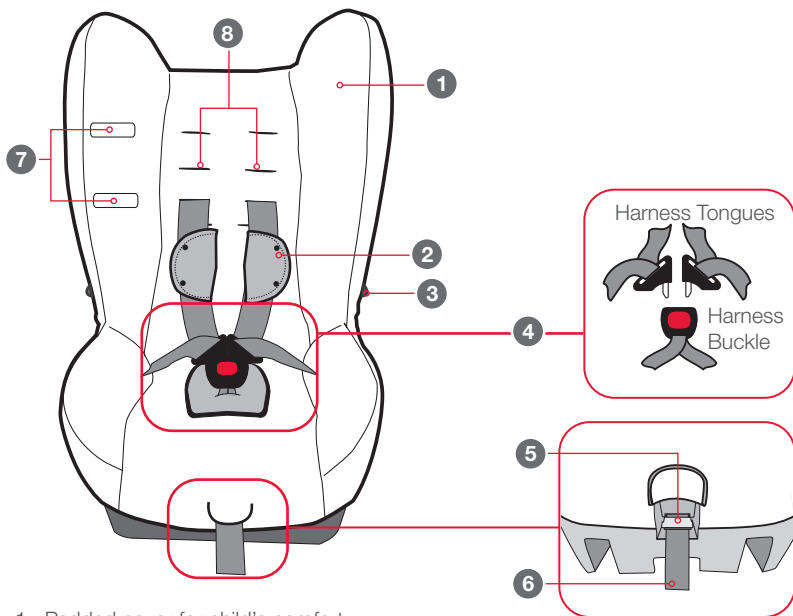

1. Padded cover for child's comfort
(May vary in style)
2. Shoulder Pads (if supplied)
3. Buckle Tongue holders (if supplied)
4. Harness Tongues and Buckle (Red button)
5. Harness Adjuster
6. Harness Adjustment Strap
7. Shoulder Height Markers
8. Slots for Harness

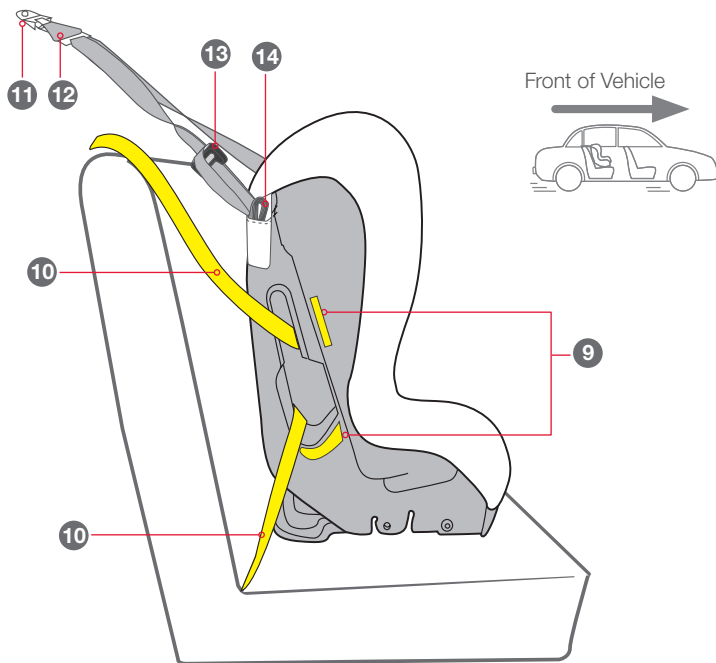

- 9. Yellow **FORWARD FACING BELT PATH** labels
- 10. Vehicle Lap-sash seatbelt
- 11. Car's Upper Anchorage Fitting
- 12. Attachment Clip
- 13. Top Tether Strap Adjuster
- 14. Top Tether Strap (shown with loose end stored in pocket).

Once the child's shoulders reach the lower shoulder height marker, the seat can be changed to the forward-facing position and used until the child's shoulders reach the upper shoulder height marker.

Continue to use the restraint in forward-facing mode until the child's shoulders reach the limit of the upper shoulder height marker. The child should not sit forward-facing until their neck muscles are able to support head. Do not move to a Booster Seat until the child has outgrown this child restraint.

Children are at risk of serious injury if they move to a booster seat too early.

Regional Road Rules may prohibit the use of a restraint in the front seat of the vehicle until the child is 4 years of age. Check your Regional Road Rules for exemptions.



WARNINGS

DO NOT USE RESTRAINT IN FORWARD-FACING MODE WITH THE REAR FACING MODE STABILISING BAR PULLED OUT.

Do not use the restraint without the top tether strap correctly attached.

If your vehicle is not fitted with an anchor point, please contact a Safety Restraint Fitting Station authorised by the relevant State Government Body for correct fitment of the restraint. In New Zealand contact the agent for the vehicle. The top tether strap must be attached to an upper anchorage point using an extension strap if necessary.

Do not use on any vehicle seat which faces sideways or rearwards.

If an airbag is fitted in the desired seating position where the child restraint is fitted, follow the vehicle manufacturer's warnings and instructions.

CONVERT THE RESTRAINT TO FORWARD FACING UPRIGHT OR RECLINE POSITION

To convert the restraint from Rearward Facing mode to Forward Facing mode:

- Remove the seat from the vehicle by disengaging the seatbelt and Top Tether.
- Pull the stabilising bar upward and away from the seat to unlock and rotate.
- Rotate the stabilising bar around so that it is in position at the bottom rear of the seat. Either recline or upright position may be set by locking into the forward or rearward slot.
- Refer to illustration below for slot locations.

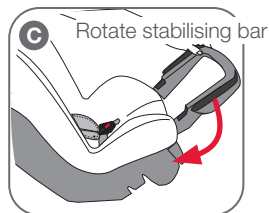
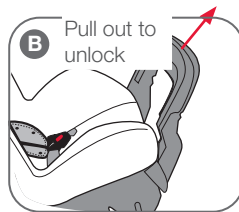

UPRIGHT MODE

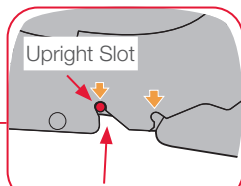
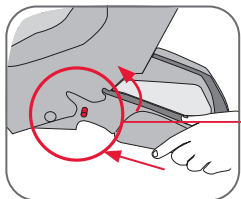

Push into UPRIGHT Slot to Lock

RECLINED MODE

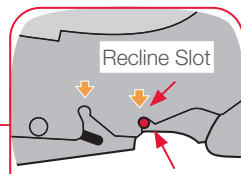
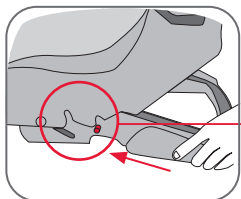

Push into RECLINE Slot to Lock

PREPARING FOR INSTALLING INTO VEHICLE - FORWARD FACING

The restraint is normally packaged in the fully upright forward facing mode. If you need to use it rearward facing you must first fully recline the restraint, and convert to rearward facing mode as shown below.

If upper anchorage strap is folded up for storage undo storage strap then lengthen. Fully press adjuster button (A) while pulling upper anchorage strap (B) to lengthen.

Fully press Adjuster Button (A) while pulling Upper Anchorage Strap (B) to lengthen.

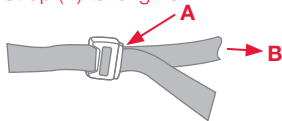

INSTALLING INTO VEHICLE - FORWARD FACING

If changing from rearward facing to forward facing:

- A. Remove the seat from the vehicle by disengaging the seatbelt as described on pages 49 and 50.
- B. Remove any insert pads (if fitted) as they are no longer required.
- C. Rotate the stabilising bar to the required forward facing position shown on page 55.

IMPORTANT:

DO NOT USE RESTRAINT IN FORWARD-FACING POSITION WITH THE STABILISING BAR PULLED OUT.

Do not recline into rearward facing position when using restraint in forward facing mode.

Ensure harness are in the correct position (Refer to page 45).

INSTALLING INTO VEHICLE FORWARD FACING

- A. Position the restraint in the car facing forward in the chosen seating position. There must be a child restraint anchorage fitting directly behind this seating position. Refer to the vehicle owners manual for the location. If not, refer to pages 62 to 65.
- B. Some vehicle seat fabrics (particularly velours) may be damaged by a child restraint used continuously. We recommend the use of a seat protector or thick towel to keep the vehicle seat in good condition.

- C. Fully lengthen seatbelt. Insert seatbelt tongue through the forward facing seatbelt path (yellow path), ensuring that the seatbelt is behind the harness straps and that the lap part of the seatbelt is below the hooks as shown on page 44.



- D. Engage seatbelt buckle & tongue. Push down on the seat, whilst pulling the sash belt firmly. This should make the lap belt tight across the restraint. Whilst holding the seatbelt tension, ensure to remove all slack from the lap part of the seatbelt **1** by pulling sash belt **2**.

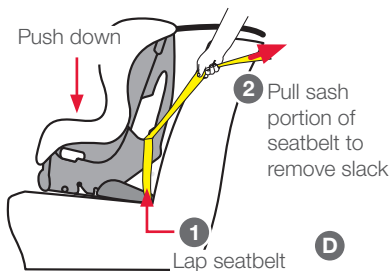

- E. The child restraint should now be firmly fitted to the vehicle seat. Allow the excess sash belt to feed back into retractor ensuring no slack has been created by the belt path.

NOTE: Seatbelt extenders should not be used if the seatbelt is long enough to secure the child restraint. If they are used then the buckle tongue must not enter the seating zone.

- F. Fit the attachment clip to the car's anchor fitting as shown. Make sure to remove as many twists as possible from the Top Tether.
- G. Tighten adjustable top tether strap by pulling adjustment strap to remove slack as shown below, but do not over-tighten causing the restraint base to lift off the vehicle seat.
- H. Fold up excess strap and use pocket to store excess strap behind seat away from child's reach.

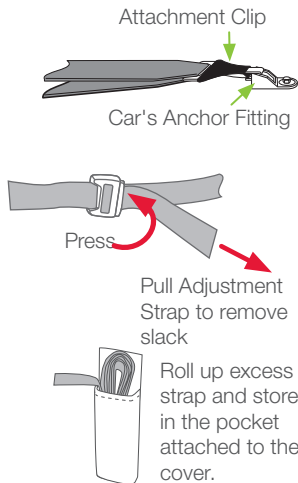

WARNING

Always attach the hook and remove slack



IMPORTANT :

Always secure the loose end of the top tether strap to prevent it hanging out of the car or being accessible by the child.

Always ensure that the car seatbelt is firmly restraining the restraint on the vehicle seat.



CAUTION:

CHILDREN CAN BE INJURED OR RESTRAINTS AND TOP TETHER STRAP DAMAGED BY UNSECURED CARGO IN A COLLISION. SECURE OR REMOVE HAZARDOUS CARGO BEFORE USING THIS CHILD RESTRAINT.

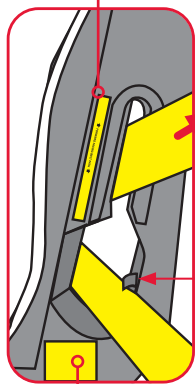
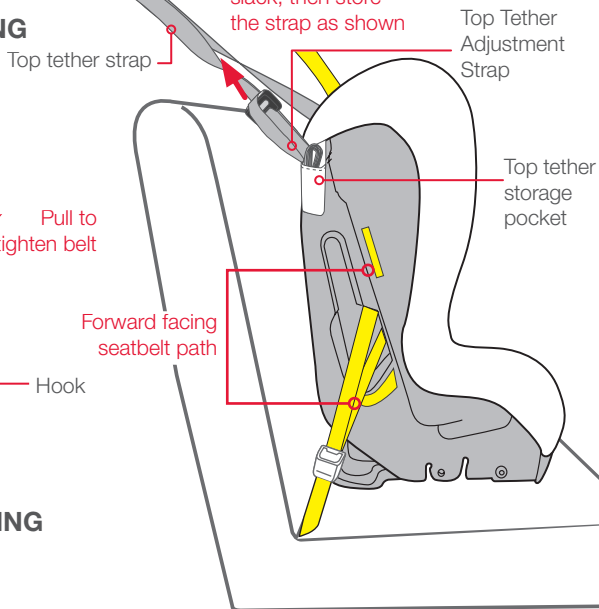
FITTING SUMMARY**FORWARD-FACING BELT PATH;**
marked in yellow.**FORWARD-FACING BELT PATH;**
marked in yellow.**IMPORTANT:**

Always secure the loose end of the top tether strap to prevent it hanging out of the car or being accessible by the child.

THIS RESTRAINT IS NOT SUITABLE FOR USE WHERE THE TOP TETHER STRAP MAY FALL INTO A SPLIT IN THE SEAT BACK OR OFF THE SIDE OF THE SEAT.

ADJUSTING SHOULDER HARNESS STRAPS HEIGHT

Correct fitment of the harness is very important as it restrains the child in the restraint. The headrest must be in the correct position and the harness must fit firmly around upper torso of the child and be positioned so as to leave the child's arms and legs free.

For forward facing mode the shoulder strap slots need to be nearest to the child's shoulders, but not lower than 25mm below the child's shoulders. If your child has reached the upper shoulder height marker then refer to page 16 for next type of restraint.

Disconnect the shoulder straps from the strap connector (see page 30) one at a time and re-thread the strap to the next slot. Remove the accessories (if fitted) when adjusting the straps.

FORWARD FACING

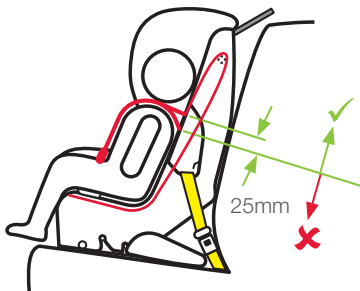

The shoulder straps must be in the slots which are nearest to the child's shoulders, but not more than 25mm below the child's shoulders.

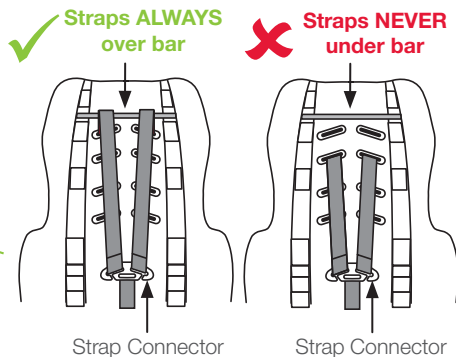

Shoulder straps **must** be threaded through appropriate shoulder strap slots then **over the top** of bar at rear of restraint.

! **IMPORTANT:** Padded Insert is not to be used when forward facing.

Always adjust the height of the shoulder straps as the child grows.

STEPS IN CHANGING SHOULDER STRAP SLOTS

- Remove the restraint from vehicle, if not already removed.
- It is better to change one strap at a time, so that the other strap will be a guide for reassembly.
- At the rear of the restraint, remove one of the harness shoulder straps from Metal Strap Connector by slipping strap through open slot.
- Pull the shoulder strap through slot.
- Insert shoulder strap through restraint slot which will position the shoulder strap level with or above the child's shoulder, **then over the metal cross bar**. Ensure that the shoulder strap passes through matching slots in cover and restraint body. If using an accessory with slots, ensure the straps are threaded through these before inserting the strap in the slots in the backrest.
- Reconnect the strap to the metal strap connector.
- Repeat for the other side.

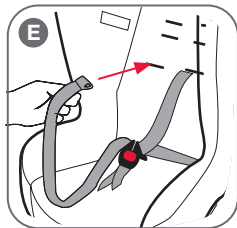
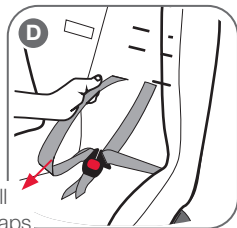
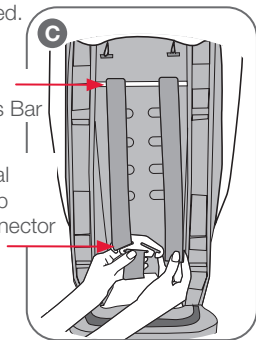

IMPORTANT:

Ensure the shoulder strap is threaded through the slot, then over the top of the bar at the rear of restraint and connected to the metal strap connector.

Do not use the restraint with harness shoulder straps set at different heights or fed through mismatching slots. Ensure harness straps are not twisted and that all straps are secure by pulling each harness strap.

Remove the accessories while adjusting harness. The accessories are not be used once child reaches the Lower Shoulder Height Marker or if it creates discomfort.

PLACING CHILD INTO RESTRAINT

- Check that the harness shoulder straps are in the correct position. Refer to page 65 for correct shoulder harness strap height and for setting up the harness.
- Lengthen harness by pressing harness adjuster button or lever. Pull out the desired amount of slack. Press the harness buckle button to release tongues. Store the tongues in the buckle tongue holders while placing child in the restraint.
- Place child in the restraint and feed each arm through shoulder straps. Place harness buckle between child's legs.
- Fit either harness tongue into the harness buckle followed by the other tongue. A click is heard when the last tongue is fully engaged.

Should the second tongue not engage - press the red button and reinsert the tongues. Ensure secure engagement by pulling harness straps. If the harness buckle does not engage correctly then it may require cleaning or seek replacement - refer to page 55. **The buckle tongues are fully engaged when both tongues are inserted and 'click' is heard.**

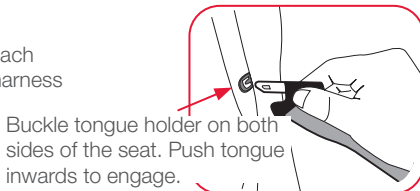
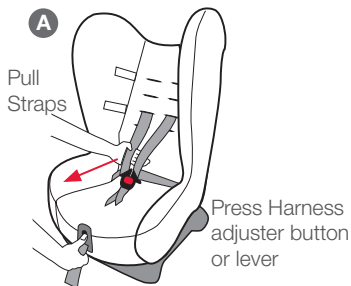

E. Ensure slack is removed from harness lap strap by pulling shoulder straps then pull harness adjustment strap to adjust harness to a comfortable, firm fit. Check that slack in straps is minimal. Shoulder harness straps must fit firmly to the child.

Do not use restraint if straps do not tighten and contact your local authorised service agent for repair.

⚠ WARNING :DO NOT LEAVE CHILDREN UNATTENDED IN THE CAR.

⚠ CAUTION:
A LOOSE HARNESS IS DANGEROUS.

Make sure that nothing is obstructing harness straps and that child's arms and legs are free with the straps in the correct location - see previous page.

Do not use the restraint if straps do not tighten and contact Safe-n-Sound® Customer Service. Refer to back cover for contact details.

Pull to remove slack from harness lap straps

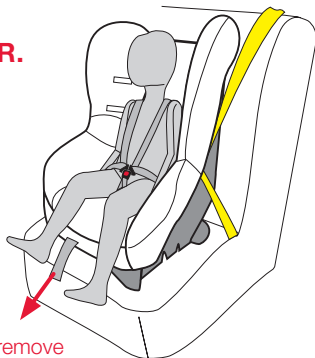
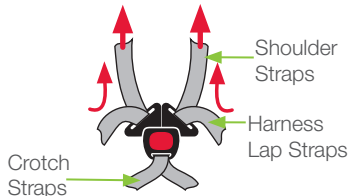

Pull to remove slack from the harness

REMOVING CHILD FROM RESTRAINT

- Push and hold the harness adjustment button while pulling both shoulder harness straps to slacken harness.
- Press the red button on harness buckle, both harness tongues will be released. Insert tongues into tongue holders to hold straps away from the child. Move shoulder straps to the side, remove child.

REMOVE RESTRAINT FROM VEHICLE

- Remove the top tether strap from pocket and fully press top tether adjuster button (A) while pulling top tether strap (B) to slacken as shown. In some vehicles loosening of the top tether strap may be difficult. If so, try pushing the restraint against the vehicle seat back or slightly lifting the restraint to release the tension.
- Disengage the attachment clip from upper anchorage fitting.
- Store loose strap in the storage pocket provided on the cover.
- Disengage the seatbelt lock-off devices on both sides of the restraint.
- Disengage seatbelt tongue from buckle and remove the seatbelt from the restraint belt paths. Allow seatbelt to feed back into seatbelt retractor.

Fully press Adjuster Button (A) while pulling top tether strap (B) to lengthen.

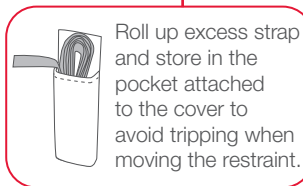
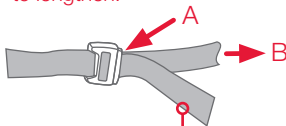

THIS RESTRAINT IS SUITABLE FOR USE ON AN AIRCRAFT WHEN INSTALLED AS DIRECTED.

HOW TO INSTALL USING AIRCRAFT LAP BELT

The child restraint must be used in accordance with the aircraft procedures, and any directions from the aircraft operator, pilot or crew.

Some child restraints may not fit in smaller aircraft and can not be used with aircraft seatbelts that contain airbags unless they can be disabled.

Inform the aircraft operator that a child restraint is intended to be used on the aircraft when booking the flight as the child restraint may not be suitable for use in that operator's aircraft.

Follow the instructions of the flight crew or pilot.

For use of the child restraint in cars in countries other than Australia and New Zealand as follows:

- (A) The child restraint may not be acceptable for use in cars.
- (B) The user may need to consult the country's local authorities, car hire companies, car insurance companies, etc. for advice.

TO FIT THE CHILD RESTRAINT TO THE AIRCRAFT SEAT IN FORWARD FACING:

- A. Set the recline position to fully upright. Position the restraint in forward-facing mode and align centrally with the chosen seating position. We recommend that you fit the restraint nearest the window or in a middle seat if in centre seating area, so it will not interfere with an adult exiting the row of seats. If possible, lift the armrests out of the way to improve access to installing the aircraft lap belt. However airline staff will direct you to the desired seat position.
- B. The top tether is not required to be used to fit the child restraint in an aircraft. Shorten the top tether strap and store in its storage pocket. Attach the tether clip to the elastic loop provided on the restraint as shown.

Store tether clip on elastic loop

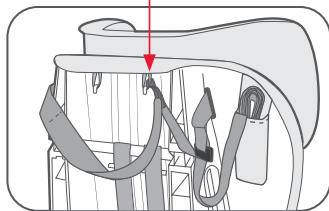

IMPORTANT:

When the tether hook is stored on the loop always remember to attach the upper tether strap when reinstalling in the car.

- C. Fully lengthen seatbelt. Thread the seatbelt into **AIRCRAFT BELT PATH** - seatbelt path marker (green marker) as shown, ensuring that the seatbelt is behind the harness straps and below the hook as shown, on each side. Engage seatbelt buckle and tongue.
- D. Push down on the restraint and remove all slack from the seatbelt.
- E. Place child in the seat, fit the harness, engage buckle and remove the slack in the harness.

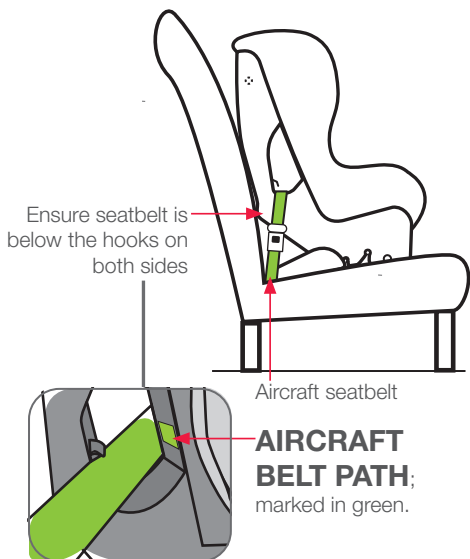

Aircraft label is located on the back of the restraint and demonstrates suitability for use on an aircraft.



This Child Restraint System meets the standards for use in aircraft as recommended by the Civil Aviation Safety Authority of Australia and the Civil Aviation Authority of New Zealand.

Only to be used on aircraft with the permission of the aircraft operator, pilot and crew.

SUITABLE FOR FORWARD USE

The top tether strap is not required to be used onboard aircraft and should be stowed securely.

REGULAR CARE OF THIS RESTRAINT:

Please check the following items regularly to ensure the safety of your child:

- A. Check the webbing of the straps for fraying,
- B. Check there are no cracks in moulding,
- C. Check the harness adjuster is operating and is clamping the webbing,
- D. Ensure the buckle is free of fluff, liquid or other matter that may enter the buckle slots. Clean the buckle if it is sluggish to engage. See next page.
- E. If any part of the restraint is cracked or broken, seek repair immediately. Contact Safe-n-Sound® Customer Service 1300 131 477

CLEANING CAR SEAT

HARDWARE: Use only mild soap to clean all metal and plastic parts of your child's restraint, using a damp sponge or cloth. Do not use chemicals or cleaning agents. Do not try and place any hardware into a washing machine.

STRAPS/HARNESS: We recommend spot cleaning straps and harness with a damp sponge or cloth using only cold or warm water. Never place any straps or harness into a washing machine or tumble dryer.

BUCKLE OPERATION

To ensure the buckle remains operational the inside of the buckle must be kept free of liquids, sand, dirt, fluff, food or similar substances. If the buckle is not operating or you do not hear a strong audible click when second tongue is inserted then the buckle needs to be washed or replaced. Contact Customer Service for assistance.

TO CLEAN HARNESS BUCKLE:

If sticky liquids such as baby formula, fruit juice, etc. get inside your harness buckle, it may become sluggish. An indication of a sluggish harness buckle is that you cannot hear a click when engaging the harness tongues. To restore the harness buckle to good working order it needs to be cleaned as follows:

- Remove the harness buckle from the restraint:
From the underside of the restraint pull each crotch 3-bar slide then turn the 3-bar slide and push through each slot.
- Place the harness buckle under warm (max. 40 degrees Celsius) running water as shown below. Let the water run through the mouth of the buckle for five minutes. Check the harness buckle is clean by engaging the harness tongues and buckle several times until you hear a click.
- If you still cannot hear a strong audible click then repeat the cleaning process several times.
- Refit the harness buckle to the restraint ensuring the red button facing outwards and the 3-bar slide is fed through the same slots.

If the harness buckle cannot be returned to its original working condition then contact Britax Customer Service for assistance.

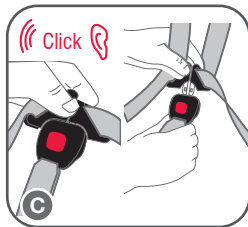
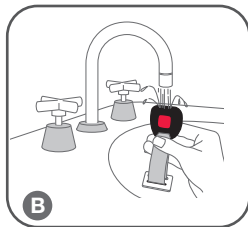
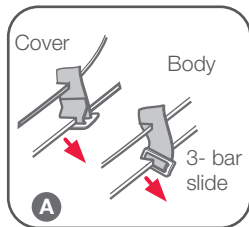

COVER (STYLE MAY VARY)

The restraint has a flame retardant cover which is removable for cleaning. Cleaning instructions are on the care label attached to the cover. If fluffy cover is fitted then washing cover prior to use will remove excess fluff.

Drying the insert pad will take additional time as the impact foam will absorb moisture. Before washing re-engage the hook and loop on the cover and inset pad to prevent the 'hook' damaging the fabric.

The cover has been designed to protect your child when seated in the restraint. Care should be taken if children either eat or drink while in the restraint as some food or drink products may cause damage or marking to the cover. Wash or clean immediately.

Do not pull sticky items from covers as the cover may be damaged - soak in water and gently remove.

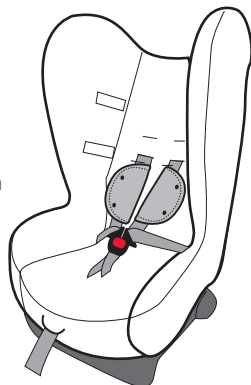
**IMPORTANT:**

Do not pull sticky items from covers as the cover may be damaged - soak in water and gently remove.

TO REMOVE COVER

Slacken and disconnect the shoulder harness straps from the metal strap connector at the back of the restraint. Then follow the sequence below A to G to remove the cover.

- A. Disengage Harness Tongues from Harness Crotch Buckle.
- B. Disengage both straps from metal strap connector. Pull the shoulder straps out of the shoulder strap slots. Remove any Head Roll or Padded Insert.
- C. Unhook Elastic Loops at the top rear of the seat.
- D. Release fabric cover overhang at the side of the seat.
- E. Undo Plastic Clips at the front of the seat.
- F. Feed Crotch Buckle through slot in cover.
- G. Carefully remove trim cover away from restraint whilst feeding through the crotch buckle, harness adjuster (button type), harness tongues and straps through the lap and crotch strap slots in the cover.

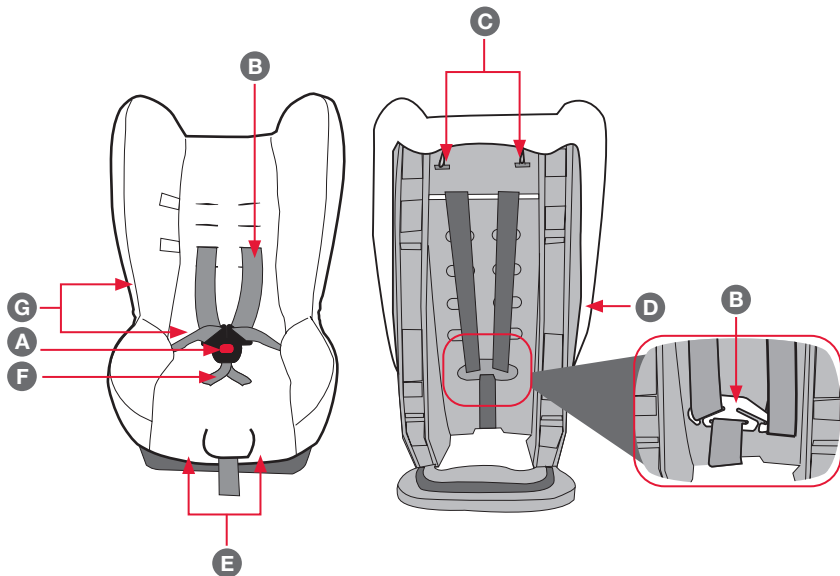

TO REPLACE COVER

1. Align and fit cover over restraint starting at top. Attach elastic loops.
2. Refit fabric overhang.
3. Feed shoulder Harness Straps through the lap strap slots.
4. Feed Crotch Buckle through slot in cover whilst fitting the cover at the lower part of the seat.
5. Re-attach Plastic Clips at the front of the seat.
6. Refit the harness straps by feeding through the appropriate shoulder strap slots. You **MUST** thread the shoulder strap over the cross bar and then re-attach the straps to metal strap connector at the back of the seat (see page 46). Refit any Head Roll or Padded Insert with slots whilst refitting the harness.

**VERY IMPORTANT:**

Only replace the cover with Safe-n-Sound® supplied replacement cover with identical shoulder height markers or a replacement cover meeting AS/NZS 8005.

Use of aftermarket accessories, that is, accessories not provided with this child restraint can reduce the safety of the child restraint and may cause injury or death. Always follow the instructions covering the use of accessories in these instructions or the instructions provided with the accessory. If an aftermarket accessory is used that is not recommended by Britax then ensure that the accessory is for this restraint and compliant with AS/NZS 8005 and is stated as suitable for use with this child restraint. The following instructions apply to accessories that may be supplied with this restraint at point of purchase. If not, a variety of Safe-n-Sound® accessories are available from various retailers of Safe-n-Sound® products.

SHOULDER PADS (If supplied)

Shoulder pads are designed to provide extra comfort for baby or child and are easily fitted to the shoulder harness straps by use of the press studs. The pads are positioned on the shoulder strap with the press studs away from the child's neck. Shoulder pads are positioned beside the child's or baby's neck.

HEAD ROLL (If supplied)

The headrest is designed to provide extra comfort and head positing and is suitable in Rearward facing only. Fitting may be by way of slots in the Head Roll, These need to be used to ensure it stays in position. See page 30 for strap connection instructions.

CROTCH PAD (if supplied)

The crotch pad is designed to provide extra comfort for baby or child and is fitted to the crotch buckle straps. It can be removed when the buckle is disengaged.

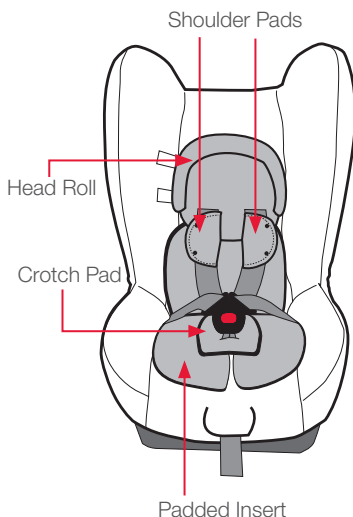

POCKETS (if fitted to the cover)

The pockets sewn on the trim are designed for your convenience. They can hold those necessary items that you need at a moments notice. e.g Bottle, face washer, toy etc.

 **CAUTION:**

If using the pocket to store filled bottles, please ensure contents are not contaminated due to prolonged storage. Ensure contents are not crushed by car door when closing.

SEAT PROTECTOR (if supplied)

Place ribbed or pocket end of the seat protector on edge of car seat, smooth back toward seat join ('A') and fit in any excess into the join of the car's seat ('A'), or for the long seat protector lay up the back of the vehicle seat.

 **CAUTION:**

The pocket is only for small, light items. **DO NOT** overload the pocket with heavy, bulky items as this may damage the pocket or cause passengers to trip over them.

NOTE: Some seat protector may not have pockets.

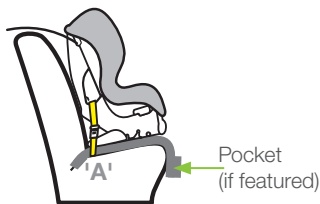
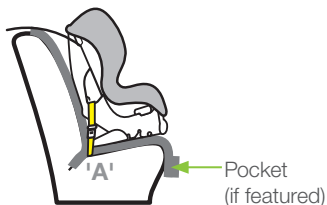
Short Seat Protector
(where supplied)**Long Seat Protector**
(where supplied)

CUP HOLDER (if supplied)

The cup holder can be fitted onto either both side of the seat.

A. Raise the cover and locate fixing slots in shell.

B. Clip cup holder into position, then re-fit cover.

Ensure the cup holder and its contents cannot be crushed by the car door. Remove or reposition the cup holder to the opposite side as required.

NOTE: Only use for holding cups and bottles.

Raise the cover here to expose fixing slots

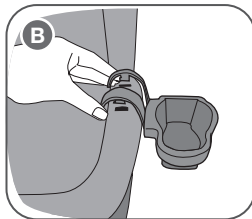
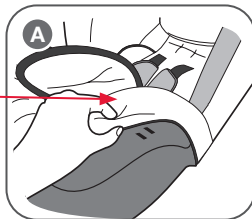

Replace the cover

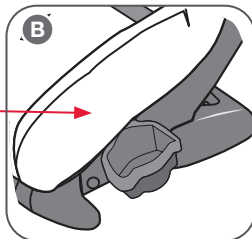

Consult the vehicle owner's handbook for location of anchorage fittings or anchorage points and the possible use of spacers. Some vehicles may have an anchor fitting fitted by the vehicle manufacturer. If anchorage points cannot be found refer to car manufacturer or local child restraint fitting station or traffic authority for optimum position of anchorage point and the use of spacers.

TOP TETHER STRAP



IMPORTANT:

THE ATTACHMENT CLIP COVER MUST ALWAYS BE USED AS IT PREVENTS THE RISK OF INCORRECT FITMENT OF THE ATTACHMENT CLIP TO THE ANCHOR FITTING. ALWAYS ENSURE THAT THE ATTACHMENT CLIP IS CORRECTLY ENGAGED TO THE ANCHOR FITTING AND NOT HOOKED OR FITTED TO ANY OTHER OBJECT BEFORE EACH USE OF THE RESTRAINT. THIS IS ESPECIALLY IMPORTANT IN VEHICLES SUCH AS STATION WAGONS, VANS, HATCH BACKS OR VEHICLES WITHOUT A FIXED PARCEL SHELF, SINCE THE ANCHOR POINT IS USUALLY NOT VISIBLE.

IMPORTANT INSTALLATION NOTE:

In some vehicles the anchor fitting in the rear vertical panel can only be installed in one way. Please refer to vehicle owner's handbook or a child restraint fitting station for correct method.



Front of Vehicle

Extension Straps

Length 300mm (Use Britax Safe-n-Sound part 0035 or 0291).

Length 600mm (Use Britax Safe-n-Sound part 0036 or 0290).

Available from all major child restraint retailers.

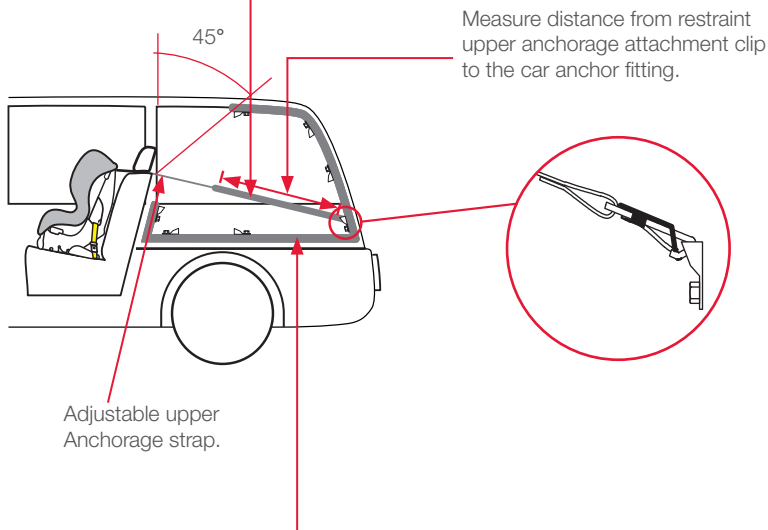

The shaded areas of this diagram illustrate the possible locations of the anchor fitting. Within each shaded area is an anchor fitting showing the correct way to install the fitting. Ensure the anchor fitting is aligned as illustrated unless stated otherwise in the vehicle owner's handbook.

IF THE CAR IS FITTED WITH CHILD RESTRAINT UPPER ANCHORAGE POINT

Locate the upper anchorage point behind the rear seating position. (Consult the car owners handbook for the location of the upper anchorage point). The upper anchorage point should be directly behind and central to the restraint. Remove thread plug from the parcel shelf/floor/roof, etc. and install attachment bolt and fitting as shown in Fig 1.

CAUTION: DO NOT OVERTIGHTEN ATTACHMENT BOLT. OVERTIGHTENING MAY FRACTURE OR BREAK BOLT. MAXIMUM TORQUE IS 20 Nm(14.75 ft.lb.)

Note: Minimum of five full turns of attachment bolt is required before tightening force is applied.

Fig.1.

UPPER ANCHORAGE FITTING

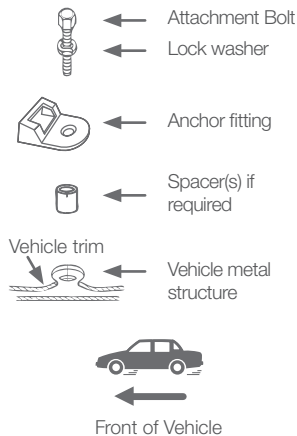

IF THE CAR IS NOT FITTED WITH CHILD RESTRAINT UPPER ANCHORAGE POINTS

FOR SEDANS ONLY - Drill 9mm diameter hole in the parcel shelf on the centre line of the seating position as shown in Fig 3. Before drilling the hole, check the underside for accessibility. Install the attachment bolt as shown in Fig 2. It is recommended that this installation be carried out by a child restraint fitting station or licenced motor mechanic.

FOR VEHICLES OTHER THAN SEDANS

- In Australia, consult your nearest child restraint fitting station or traffic authority for vehicle inspection to find the best, correct position for the placement of the upper anchorage point, and for the correct attachment bolt length and use of spacers. In New Zealand, consult the agent for the vehicle. Note to Queensland purchasers: The installation of anchorage points must be approved by authorised officers appointed by Queensland Transport. Authorised officers can be sourced from all Queensland Transport Customer Service and Queensland Ambulance Service Centres.

Fig.2.

UPPER ANCHORAGE FITTINGS FOR SEDANS ONLY

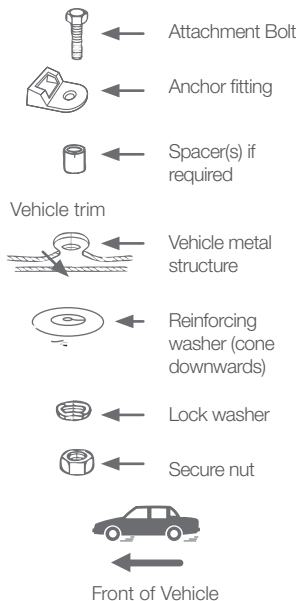

ONLY USE A 5/16 UNC GRADE 5 BOLT. IF THE BOLT IS NOT THE CORRECT LENGTH THE CAR MANUFACTURER'S HAND BOOK CAN PROVIDE ADVICE ON THE CORRECT LENGTH BOLT.



WARNING

CHILD RESTRAINTS MUST NOT BE ATTACHED TO UNSOUND METAL OR TO WOOD, OR SYNTHETIC STRUCTURES. WHEN DRILLING 9 MM HOLE DO NOT DRILL THROUGH FUEL LINES, FUEL TANKS, ELECTRICAL WIRING, OR RADIO SPEAKERS. WEBBING STRAPS MUST BE PROTECTED FROM SHARP CORNERS AND EDGES. THE ANCHOR FITTING MUST BE USED ONLY AS DESCRIBED ABOVE. IT MUST NOT BE HOOKED ONTO ANY OTHER OBJECT.

CAR INSTALLATION ACCESSORIES

(From retailers of Britax Safe-n-Sound® products)

EXTRA ANCHOR KITS: Available for using the restraint in additional cars.

Re-order no: 0038

EXTENSION STRAPS: May be required for cars without a fixed parcel shelf.

Re-order no: 0035 (length 300mm) or 0036 (length 600mm)



Note: Marking on the top of a Grade 5 Bolt.

Fig.3.

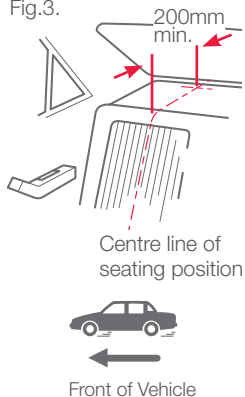

SAFETY

Never hold a baby in arms when riding in a motor vehicle. In this position the baby could be thrown against the dashboard, windscreen or other occupant and suffer serious injury or death.

When riding in a motor vehicle never nurse a baby and use the same seat belt for both of you. In this position the baby or child could be crushed.

Never breast feed a baby while car is in motion.

Children must be secured in appropriate restraints at all times when the car is in motion. Children travelling unrestrained or standing up in the car are in danger of serious injury or death. Traffic regulations in all states require children to be secured in child restraints or adult seat belts where available.

Plan your trip with frequent comfort stops to reduce stress on babies, young children and driver. Keep the car well ventilated to reduce heat stress. Car windows should be kept open to maintain a good flow of fresh air.

Never leave babies or toddlers in a stationary car because of the risk of heat exhaustion.

Ensure babies and toddlers are adequately shaded from direct sunlight through side or rear windows.

Check the car is ventilated by use opening windows or using the car's ventilation system taking in external air. Recirculation setting is not suitable for providing ventilation.

Be on guard against carbon monoxide poisoning which can occur through only a slight leak in the exhaust system while travelling in a closed car.

Securely stow all heavy objects, feeding bottles, etc. that could become missiles during an accident and cause injury to any occupant.

CLOTHING/BATHING

Since it is often warmer in the car, dress the baby in light clothing.

Do not harness an infant wrapped in a blanket or swaddled. Any blanket or wrap must only be placed over the harness and infant.

If your restraint has been involved in a severe crash, you should destroy the restraint even if no damage is obvious. Some insurance companies offer vehicle insurance which covers or partially covers the replacement of your child restraint. Contact your insurance company for further details. Your insurance company may require you to keep the child restraint for assessment, **but do not use the child restraint after a severe crash**. To assist you in making an accident insurance claim cut the following statement and include it with your claim.

NOTICE TO INSURANCE COMPANY CHILD RESTRAINT INVOLVED IN AN ACCIDENT

All Britax Safe-n-Sound® child restraints are manufactured to Australian/New Zealand Standards AS/NZS1754-2013 which require us to advise users of child restraints to "Destroy the entire restraint if it has been in use in a severe crash, even if no damage is obvious". The joint Australian/New Zealand Standards committee CS/85, advise that this statement applies whether a child was in the child restraint or not. A severe crash, we consider as being one where the main body structure of the vehicle is distorted.

There is no method of determining if the restraint has been damaged and we concur with the Australian/New Zealand Standards in recommending destruction of the child restraint.

This notice is to advise you of the requirements of the Australian/New Zealand Standards and our obligation in complying with the standards.

Please assist the owner of this restraint in their claim.

Britax Childcare Pty. Ltd.

(Incorporated in Victoria)

A.B.N 55 006 773 600

Head office and registered address:

Level 4, 650 Lorimer Street, Port Melbourne, VIC, 3207

P.O. Box 5119 Garden City, VIC, 3207

Telephone: 1300 303 330

New Zealand Office:

Britax Childcare NZ Limited.

PO Box 100-247 Auckland 9

Telephone: 0508 688 822

We would never want you to experience an accident, but unfortunately accidents do happen.

If you experience an accident you may be eligible for a free replacement.

The Britax Safe-n-Sound® Crash Exchange Program is a voluntary program designed to ensure that our children are safe and that any seat that may have experienced a severe crash is taken out of the market.

There is no method of determining if the restraint has been damaged in a severe crash, so the restraint should be destroyed as the crash may reduce the child restraints ability to perform.

Since its inception in 2006, the Crash Exchange program has helped 100's of families ensure that their children have new restraints and that the restraints are not sold second hand placing others at risk.

Our Crash Exchange Terms and Application form are accessible on our website. Please visit www.britax.com.au for further information.



AUSTRALIA

Britax Childcare Pty. Ltd.
A.B.N 55 006 773 600

Head office and registered address:

Level 4, 650 Lorimer Street, Port Melbourne, VIC, 3207
P.O. Box 5119 Garden City, VIC, 3207

Customer Service 1300 303 330

Email au-support@britax.com

www.britax.com.au

NEW ZEALAND

Britax Childcare (NZ) Ltd.

Customer Service 0508 688 822

Email nzoffice@britax.com

www.britax.com.nz

INTERNATIONAL ENQUIRIES

Contact your local Distributor







Series No. BS0072K-020133
Scan QR code for features,
how to use and installation.

WARRANTY

Our goods come with guarantees that cannot be excluded under the Australian Consumer Law. You are entitled to a replacement or refund for a major failure and compensation for any other reasonable foreseeable loss or damage. You are also entitled to have the goods repaired or replaced if the goods fail to be acceptable quality and the failure does not amount to a major failure.

For the full terms of the Warranty refer to the Britax website
www.britax.com.au/service-support/warranty

In our constant pursuit of excellence we may alter this product and specification without notice. This product may be covered by Australian and International patents and designs or pending applications. Safe-n-Sound® is a registered trademark and all Safe-n-Sound® model names are trademarks of Britax Childcare Pty Ltd.

